

VARIO PSU

rayTEC[®]

Installation and Setup Guide for the VARIO PSU

Designed to power all VARIO illuminators (including VARIO IP)



PSU-VAR-20W-1 (small)

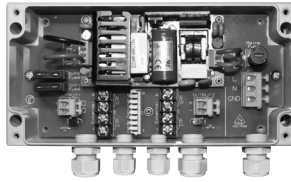

PSU-VAR-50W-2 (medium)

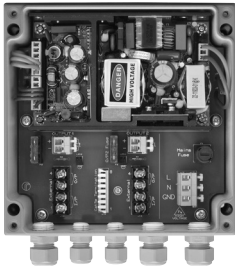

PSU-VAR-100W-2 (large)

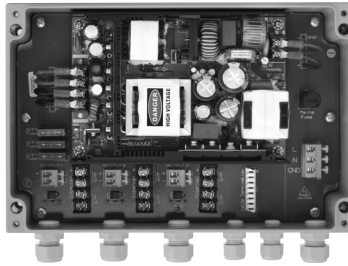

PSU-VAR-150W-3 (x-large)

Contents

Page 2 - 3	Installation
Page 4	Setup
Page 5	VARIO Standard Bracketry
Page 6	VARIO PSU Specifications
Page 7 - 8	Troubleshooting

Installation

Warnings



Isolate mains before removing PSU cover

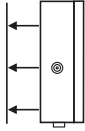

Mount PSU to flat surface



Install in a well ventilated area

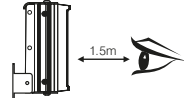

Do not continually stare at lamp

1 Select interchangeable lens and mount VARIO illuminator

VARIO is factory set and delivered with a 35° beam width. To alter to 10°, simply remove interchangeable holographic diffuser (IHD). To alter to 60°, replace with other IHD supplied.

2 Mount PSU

Mount PSU on wall/flat surface with glands facing down

3 Connect illuminator to PSU

VARIO PSU provides 24V DC

Wiring – six core cable

Red wire +
Black wire -

Installers can extend or reduce lead length using appropriate cable and weather proof box

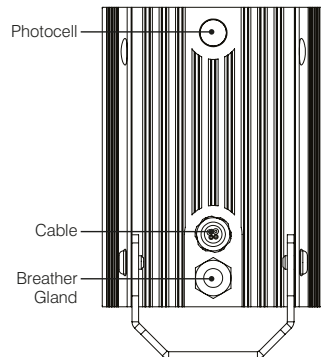
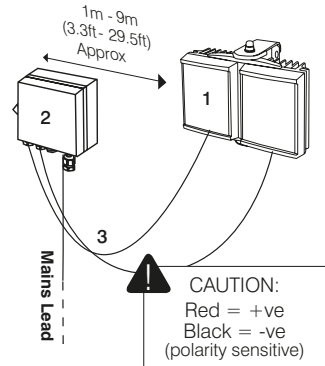

4 PSU Connections

Connect photocell following output/telemetry if required into 'Fast Connect' wiring terminal.

Photocell following contact - White & Yellow wires

Volt free output. Non polarity sensitive.

Terminal 1 – white wire

Terminal 2 – Yellow wire

Telemetry input - Orange & Purple wires

Volt free/dry contact or TTL input

Terminal 3 – Orange wire

Terminal 4 – Purple wire

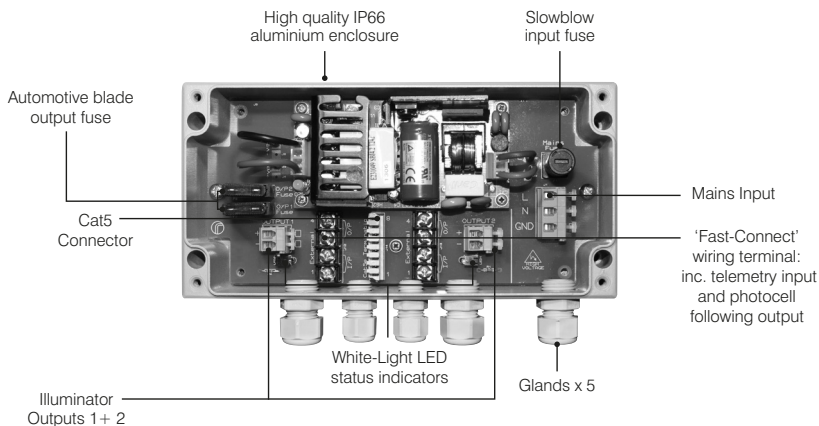

Image featuring PSU-VAR-50W-2 (medium)

5 Connect PSU to mains

CAUTION: Ensure cable glands and PSU lid are water tight by tightening the fixings

Golden Rules

Ensure PSU lid orientation has warning label in line with glands (see PSU diagram, right)

Ensure PSU is fully water tight

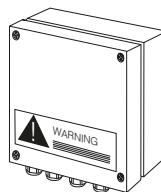

Setup

1 Position illuminator

Position illuminator adjacent to camera and point towards scene (Optional night set-up for optimum image performance)

2 Adjust vertical angle

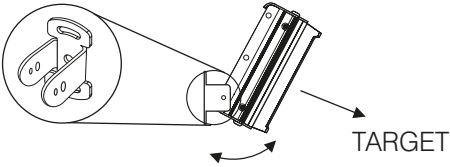

3 Adjust horizontal angle

Adjust horizontal angle via Adaptive Illumination (AI) if required (VARIO AI illuminators only)

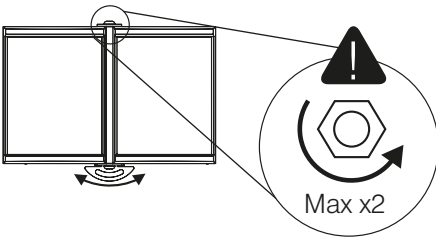

CAUTION: Do not fully loosen AI bolt

4 Tighten all fixings

5 Final illuminator configuration

Complete configuration and final setup using VARIO Remote Controller or VARIO IP Integrated Web Interface (or via 3rd party VMS if applicable)

Match illumination to camera field of view

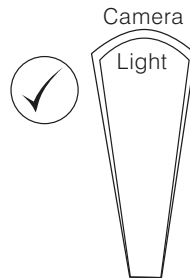
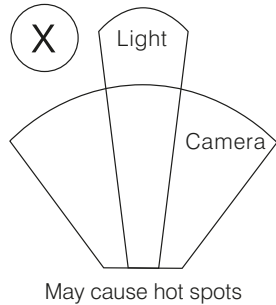
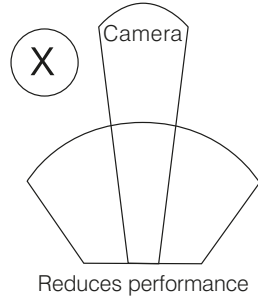

Standard Bracketry

VARIO 2 series

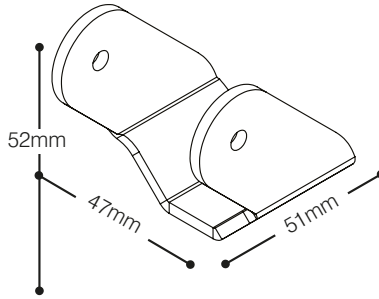

VARIO 4 series

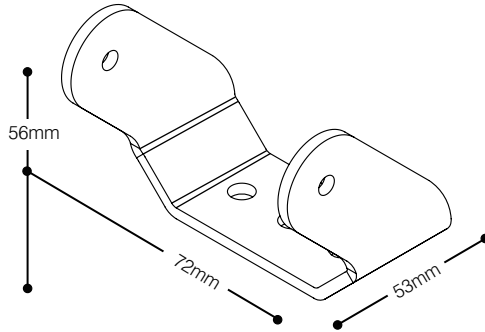

VARIO 8 series

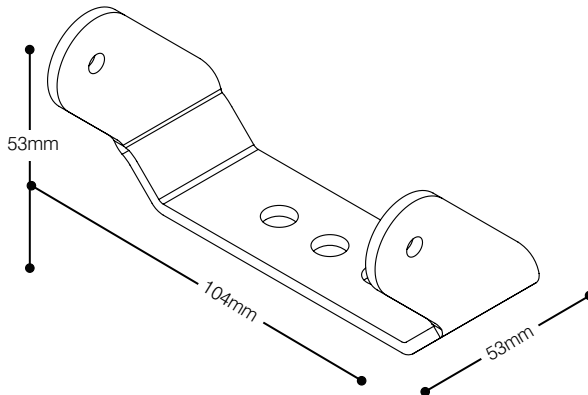

Other bracket options available – see specific illuminator instructions.
See VARIO AI Installation instructions for VARIO AI bracketry options.

PSU Specifications

	PSU-VAR-20W-1 (small)	PSU-VAR-50W-2 (medium)	PSU-VAR-100W-2 (large)	PSU-VAR-150W-3 (x-large)
Illuminators	1 x VARIO 2 series Plus aux output (max 8w)	2 x VARIO 4 series	2 x VARIO 8 series or 1 x VARIO 16 series	3 x VARIO 8 series
Other Illuminator options		4 x VARIO 2 series *	4 x VARIO 4 series * 8 x VARIO 2 series *	1 x VARIO 16 series* 6 x VARIO 4 series*
	*Please note: for medium, large and x-large PSUs powering an increased number of VARIO illuminators, the total power of the illuminators must be equivalent to the PSU max output - illuminator output cables may also need to be commoned together to suit the number of available glands.			
	Mixed model sizes of VARIO illuminators can be powered from the same PSU e.g. PSU-VAR-50W-2 can also run 2 x VARIO 2 series and 1 x VARIO 4 series.			
Input	100-230V AC			
Input Fuse Type	20mm, slowblow, user replaceable without disconnecting mains input			
Input Fuse Rating	1A	2.5A	2.5A	2.5A
Max Output	20W	50W	100W	150W
Output for VARIO Illuminators	1 for VARIO 2 series	2 for VARIO 4 series or equivalent power units	2 for VARIO 8 series or equivalent power units	3 for VARIO 8 series or equivalent power units
Output Voltage	24V DC			
Output Fuse Type	automotive, blade, user replaceable			
Output Fuse Rating	3A	3A	5A	5A
FastConnect™ wiring	Quick and easy wiring for VARIO input and output connections - 4 way robust terminal for telemetry input and photocell following output			
White Light status LEDs	White-Light LED status indicators on all fused outputs to indicate correct voltage and to provide support illumination during installation and maintenance			
Cat5 Connector	N/A	Cat5 Connector for VARIO IP	Cat5 Connector for VARIO IP	Cat5 Connector for VARIO IP
Glands	2x M16, 2x M12, IP68	3x M16, 2x M12, IP68	3x M16, 2x M12, IP68	4x M16, 2x M12, IP68
Enclosure construction	High quality, power coated, IP66 aluminium			
PSU Dimensions	165x129x61 mm (6.5 x 5 x 2.4")	200x131x61 mm (7.9 x 5.2 x 2.4")	160x191x81 mm (6.3 x 7.5 x 3.2")	240x191x81 mm (9.4 x 7.5 x 3.2")
Drilling Dimensions	4 x M4 holes 145 x 63 mm (5.7 x 2.5")	4 x M4 holes 185 x 63mm (7.3 x 2.5")	4 x M4 holes 145 x 123mm (5.7 x 4.8")	4 x M4 holes 225 x 123mm (8.9 x 4.8")
Weight	0.9kg (2.0 lbs)	1.0kg (2.2 lbs)	1.7kg (3.7 lbs)	2.4kg (5.3 lbs)
IP Rating	IP66			
Certification	CE compliant			

Troubleshooting

Ensure all tests are undertaken by a qualified, trained engineer. Ensure safe working practices are followed at all times.

Step 1 Basics

- Check polarity of illuminator connection: red= +ve, black= -ve
- Ensure PSU outputs provide 24V DC
- Ensure telemetry wires are shorted out or closed contact input (zero volt) is applied
- Check photocell is working. Cover illuminator photocell fully, light should turn on. It is sometimes difficult to see Infra-Red lamps working in high brightness conditions.
- Check mains input
- Check fuses intact
- If longer cables used, ensure sufficient voltage is provided to allow for drops across the cable

If OK...

Step 2 Lamp Test

- Check current is being drawn – amount of current will depend on power setting of unit. Please note – use appropriate DC multimeter
- To test this you must ensure photocell fully covered (or disabled using optional VARIO remote controller or VARIO IP web interface) and ensure telemetry wires are shorted out or closed contact input (zero volt) is applied

Step 3 Set-up Camera, lens and illumination

- Check camera lens – fully open at night & set correctly
- Check model number to Raytec performance specification to ensure required distance is achievable;
 - Check illuminator is set to max power
 - Check orientation of illuminator and ensure it is pointing in correct direction
 - Check angle of illuminator (Holographic lens) – Too narrow may cause hot spots and the aperture of the camera lens to close down. Too wide and there may be insufficient light on scene and light going where it is not needed.
- Check the LED status indicator on standard VARIO illuminators (not applicable for VARIO IP) – if a flashing red light is visible in programming mode, please check the input voltage of the unit. The feedback system will respond differently depending on what mode the unit is in (see specific VARIO installation guide for further details)

Step 4 Call Raytec for further assistance

Note down:

- Model and serial number of PSU/ illuminator
- Camera make and model

If the Raytec lamp or remote control is still not delivering the required performance, please contact us for further assistance:

Raytec Global Tel: +44 (0)1670 520055

Raytec Warranty

Please register you VARIO PSU for its 3 year warranty by visiting www.rayteccctv.com/products/warranty-card

The Raytec logo is displayed in a bold, lowercase, sans-serif font. The letter 'r' is significantly larger than the other letters. A registered trademark symbol (®) is positioned to the upper right of the 'c'.

Global HQ
T: +44 (0) 1670 520055
F: +44 (0) 1670 819760
sales@rayteccctv.com

America
T: +1 613 270 9990
ussales@rayteccctv.com

www.rayteccctv.com