



Distributed Elevator Controller

Quick Start Guide

UD03824B

1 Appearance

- Relay: NO Closed (Solid Green)
NC Closed (Off)
- RS-485: No Communication (Off)
Communication (Solid Green)
- Power On: Solid Green
- Running Properly: (Flashing Green)
Exception: (Solid Red)

Indicator

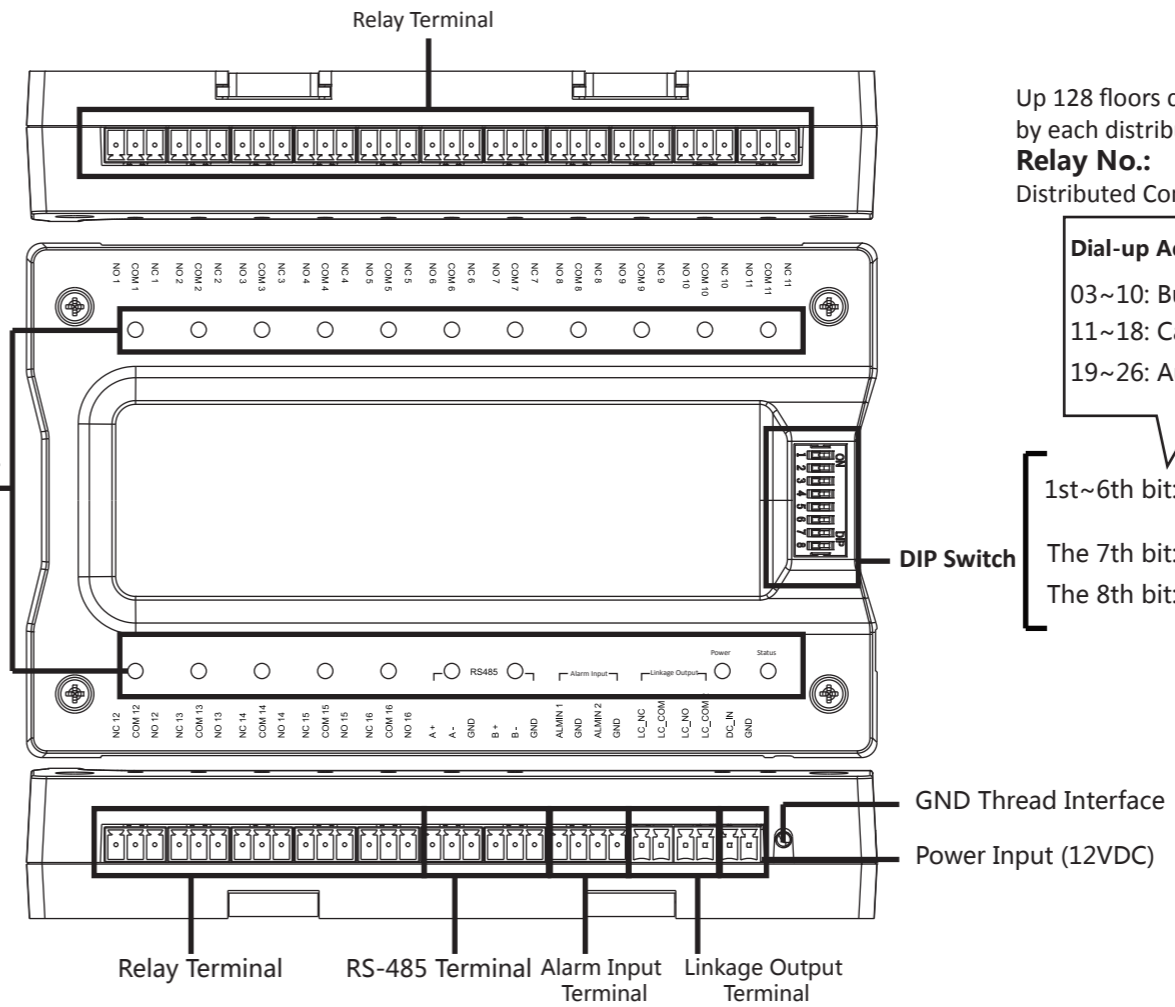

Up 128 floors can be controlled by each distributed contrllor.
Relay No.:
Distributed Controller Dial-up No. + Relay Serial No.

Dial-up Address Allocation:
03~10: Button Relay
11~18: Call Elevator Relay
19~26: Auto Button Relay

1st~6th bit: Distributed Controller Address Allocation
The 7th bit: Reserved
The 8th bit: NO/NC Status Reversal

Dimensions (mm)

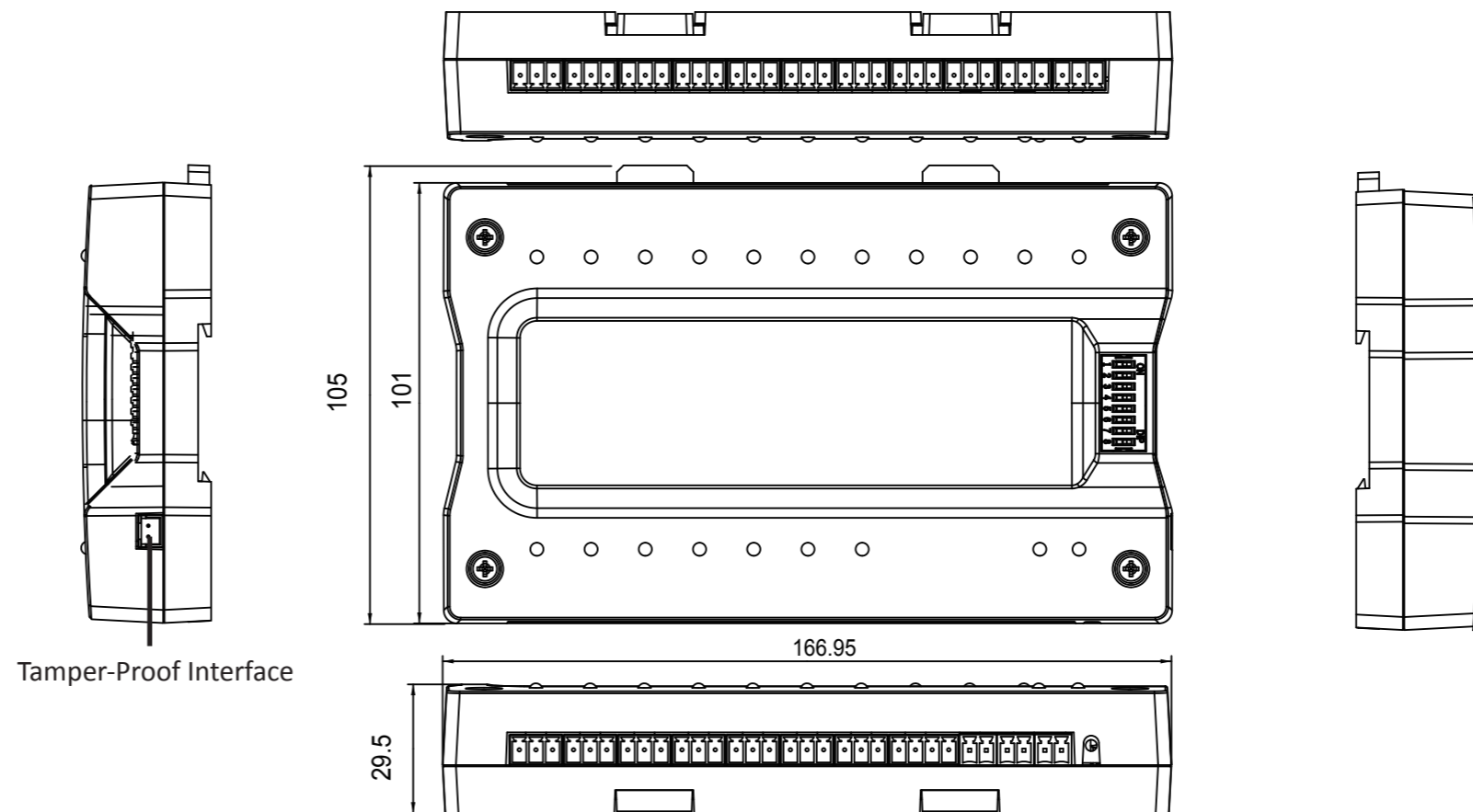

©2016 Hangzhou Hikvision Digital Technology Co., Ltd.
It includes instructions on how to use the Product. The software embodied in the Product is governed by the user license agreement covering that Product.
About this Manual
This Manual is subject to domestic and international copyright protection. Hangzhou Hikvision Digital Technology Co., Ltd. ("Hikvision") reserves all rights to this manual. This manual cannot be reproduced, changed, translated, or distributed, partially or wholly, by any means, without the prior written permission of Hikvision.

Trademarks
HIKVISION and other Hikvision marks are the property of Hikvision and are registered trademarks or the subject of applications for the same by Hikvision and/or its affiliates. Other trademarks mentioned in this manual are the properties of their respective owners. No right of license is given to use such trademarks without express permission.

Legal Disclaimer
TO THE MAXIMUM EXTENT PERMITTED BY APPLICABLE LAW, THE PRODUCT DESCRIBED, WITH ITS HARDWARE, SOFTWARE AND FIRMWARE, IS PROVIDED "AS IS", WITH ALL FAULTS AND ERRORS, AND HIKVISION MAKES NO WARRANTIES, EXPRESS OR IMPLIED, INCLUDING WITHOUT LIMITATION, MERCHANTABILITY, SATISFACTORY QUALITY, FITNESS FOR A PARTICULAR PURPOSE, AND NON-INFRINGEMENT OF THIRD PARTY. IN NO EVENT WILL HIKVISION, ITS DIRECTORS, OFFICERS, EMPLOYEES, OR AGENTS BE LIABLE TO YOU FOR ANY SPECIAL, CONSEQUENTIAL, INCIDENTAL, OR INDIRECT DAMAGES, INCLUDING, AMONG OTHERS, DAMAGES FOR LOSS OF BUSINESS PROFITS, BUSINESS INTERRUPTION, OR LOSS OF DATA OR DOCUMENTATION, IN CONNECTION WITH THE USE OF THIS PRODUCT, EVEN IF HIKVISION HAS BEEN ADVISED OF THE POSSIBILITY OF SUCH DAMAGES.
REGARDING TO THE PRODUCT WITH INTERNET ACCESS, THE USE OF PRODUCT SHALL BE WHOLLY AT YOUR OWN RISKS. HIKVISION SHALL NOT TAKE ANY RESPONSIBILITIES FOR ABNORMAL OPERATION, PRIVACY LEAKAGE OR OTHER DAMAGES RESULTING FROM CYBER ATTACK, HACKER ATTACK, VIRUS INSPECTION, OR OTHER INTERNET SECURITY RISKS; HOWEVER, HIKVISION WILL PROVIDE TIMELY TECHNICAL SUPPORT IF REQUIRED.
SURVEILLANCE LAWS VARY BY JURISDICTION. PLEASE CHECK ALL RELEVANT LAWS IN YOUR JURISDICTION BEFORE USING THIS PRODUCT IN ORDER TO ENSURE THAT YOUR USE CONFORMS THE APPLICABLE LAW. HIKVISION SHALL NOT BE LIABLE IN THE EVENT THAT THIS PRODUCT IS USED WITH ILLEGITIMATE PURPOSES.
IN THE EVENT OF ANY CONFLICTS BETWEEN THIS MANUAL AND THE APPLICABLE LAW, THE LATER PREVAILS.

2 Installation

Before you start:

- The minimum bearing weight of the wall or other places should be three times heavier than the device weight.
- Dial-up before you install.

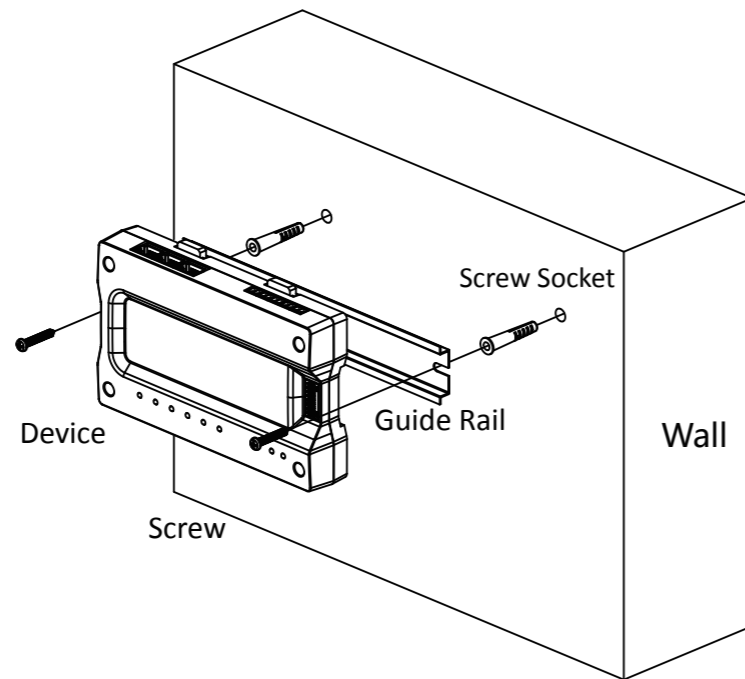

Steps:

1. Drill holes on the wall or other places according to the holes on the guide rail.
2. Insert the screw sockets of the set screws (supplied) in the drilled holes.
3. Secure the guide rail on the wall or other places with the screws (supplied).
4. Push the device to the guide rail and fix it.

3 Device Wiring

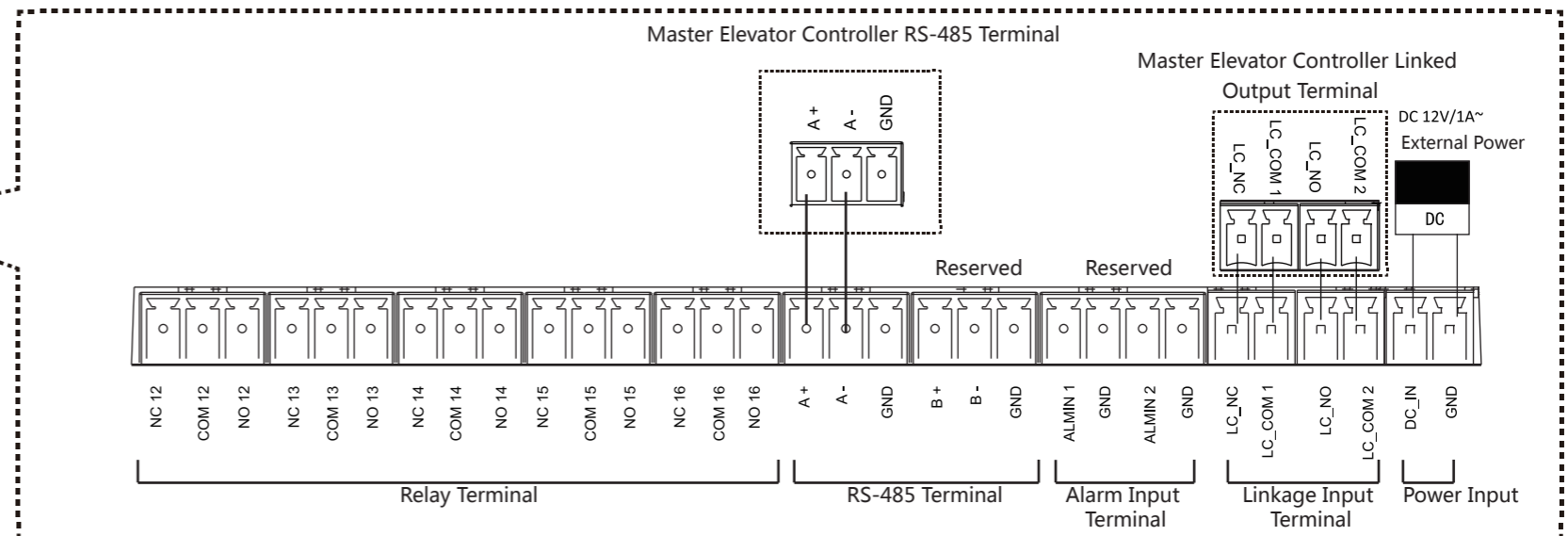
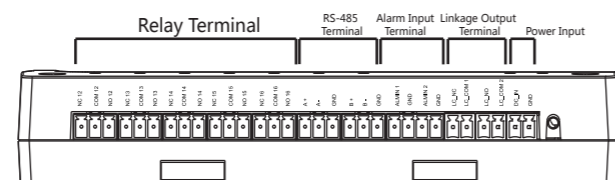
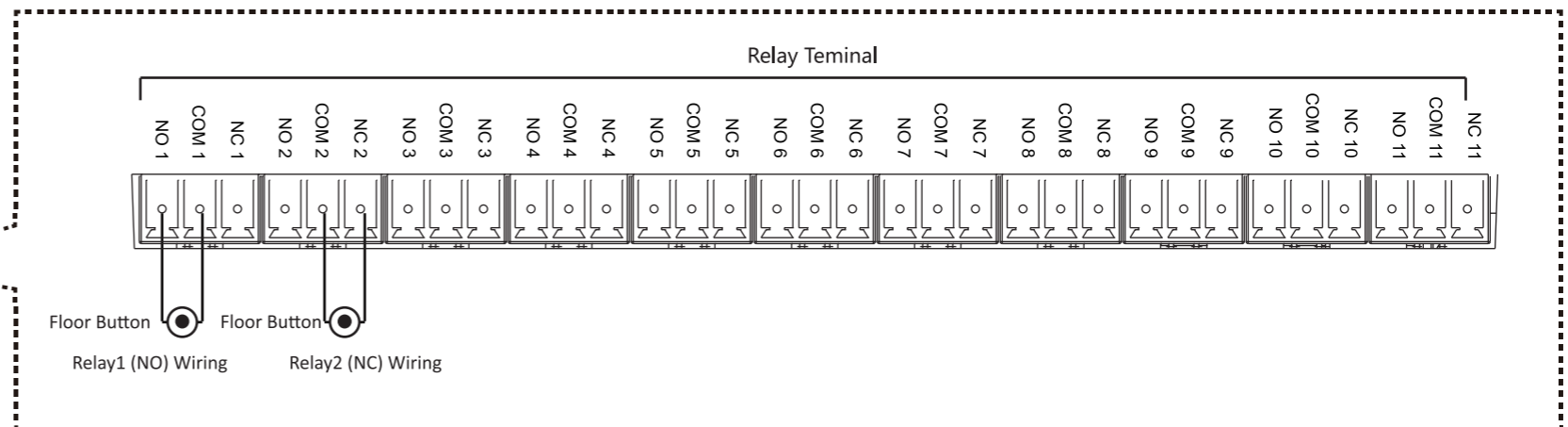
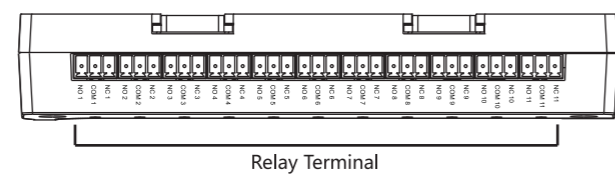

Relay NO Wiring: Wire the call elevator distributed controller and the call elevator relay, or wire the auto button distributed controller and the auto button relay to make sure the call elevator control and the auto button elevator control is invalid when powering off. The elevator will not stay between floors.

Relay NC Wiring: Wire the button distributed controller and the button relay to make sure all buttons are valid when powering off.