

## DS-2CE72HFT-F 5 MP Full Time Color Camera



ColorVu



- 5 MP, 2560 × 1944 resolution
- 24-hour color image
- 130 dB true WDR, 3D DNR
- 3.6 mm, 6 mm fixed focal lens
- Smart Light, up to 20 m white light distance
- 4 in 1 video output (switchable TVI/AHD/CVI/CVBS)
- IP67



## Specification

Camera	
Image Sensor	5 MP CMOS
Signal System	PAL/NTSC
Resolution	2560 (H) × 1944 (V)
Frame Rate	TVI: 5MP@20fps, 4MP@30fps, 4MP@25fps, 1080p@30fps, 1080p@25fps CVI: 4MP@30fps, 4MP@25fps AHD: 5MP@20fps, 4MP@30fps, 4MP@25fps CVBS: PAL/NTSC
Min. illumination	0.0005 Lux @ (F1.0, AGC ON), 0 Lux with White Light
Shutter Time	PAL: 1/25 s to 1/50, 000 s NTSC: 1/30 s to 1/50, 000 s
Slow Shutter	Max. 16 times
Lens	3.6 mm, 6 mm fixed lens
Horizontal Field of View	80.1° (3.6 mm), 49.3° (6 mm)
Lens Mount	M16
Strobe Light Alarm	Yes
Day & Night	Color
WDR (Wide Dynamic Range)	≥130 dB
Angle Adjustment	Pan: 0 to 360°, Tilt: 0 to 75°, Rotation: 0 to 360°
Menu	
White Light	Auto/Off
Image Mode	STD/HIGH-SAT
AGC	Yes
Day/Night Mode	Color
White Balance	Auto/Manual
AE (Auto Exposure) Mode	WDR/BLC/HLC/Global/HLS/Anti-banding
Privacy Mask	4 programmable privacy masks
Motion Detection	4 programmable motion areas
Noise Reduction	3D DNR
Language	English
Function	Brightness, Sharpness, Mirror, Smart Light
Interface	
Video Output	Switchable TVI/AHD/CVI/CVBS
General	
Operating Conditions	-40 °C to 60 °C (-40 °F to 140 °F), humidity 90% or less (non-condensing)
Power Supply	12 VDC ± 25% <i>*You are recommended to use one power adapter to supply the power for one camera.</i>

General	
Power Consumption	Max. 3.5 W
Protection Level	IP67
Material	Main Body: Metal Enclosure: Plastic
White Light Range	Up to 20 m
Communication	HIKVISION-C
Dimensions	Φ 109.82 mm × 85.56 mm (4.32" × 3.37")
Weight	Approx. 350 g ( 0.77 lb.)

### Available Model

DS-2CE72HFT-F

### Dimension

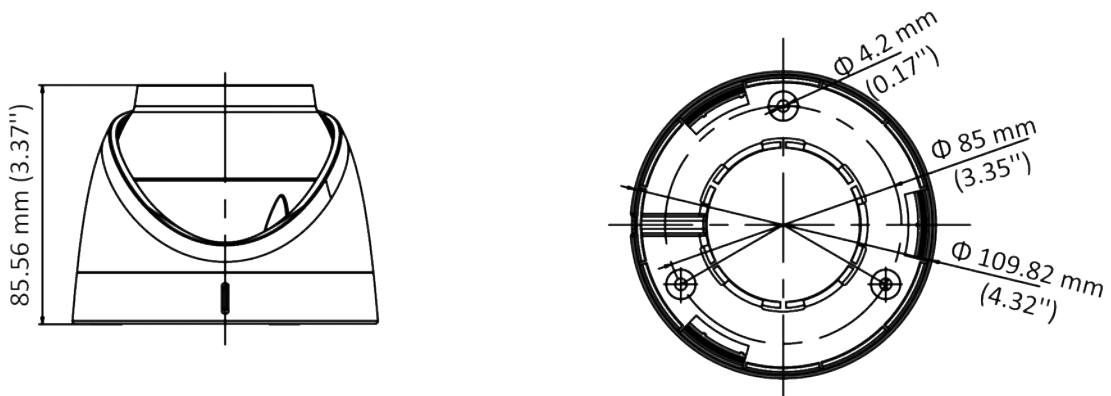

### Accessory

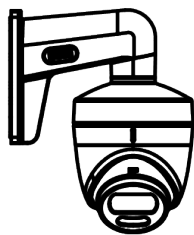

DS-1272ZJ-110-TRS  
Wall Mount

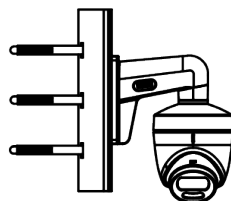
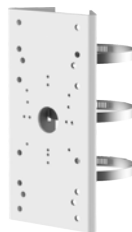

DS-1275ZJ-SUS  
Vertical Pole Mount

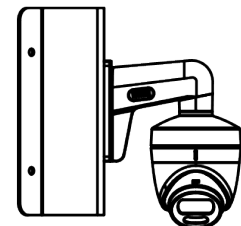

DS-1276ZJ-SUS  
Corner Mount

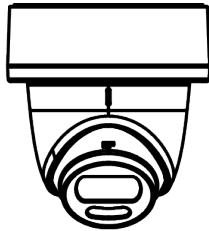

**DS-1280ZJ-S**  
Junction Box

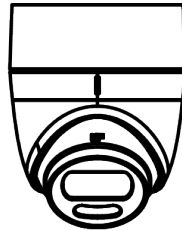

**DS-1280ZJ-TR13**  
Junction Box



**DS-1281ZJ-S**  
Inclined Ceiling Mount

Distributed by



## HIKVISION

### Headquarters

No.555 Qianmo Road, Binjiang District,  
Hangzhou 310051, China  
T +86-571-8807-5998  
overseasbusiness@hikvision.com

**Hikvision USA**  
T +1-909-895-0400  
sales.usa@hikvision.com

**Hikvision Australia**  
T +61-2-8599-4233  
salesau@hikvision.com

**Hikvision India**  
T +91-22-28469900  
sales@pramahikvision.com

**Hikvision Canada**  
T +1-866-200-6690  
sales.canada@hikvision.com

**Hikvision Thailand**  
T +662-275-9949  
sales.thailand@hikvision.com

**Hikvision Europe**  
T +31-23-5542770  
sales.eu@hikvision.com

**Hikvision Italy**  
T +39-0438-6902  
info.it@hikvision.com

**Hikvision Brazil**  
T +55 11 3318-0050  
Latam.support@hikvision.com

**Hikvision Turkey**  
T +90 (216)521 7070- 7074  
sales.tr@hikvision.com

**Hikvision Malaysia**  
T +601-7652-2413  
sales.my@hikvision.com

**Hikvision UK & Ireland**  
T +01628-902140  
sales.uk@hikvision.com

**Hikvision South Africa**  
Tel: +27 (10) 0351172  
sale.africa@hikvision.com

**Hikvision France**  
T +33(0)1-85-330-450  
info.fr@hikvision.com

**Hikvision Kazakhstan**  
T +7-727-9730667  
nikla.panfilov@hikvision.ru

**Hikvision Vietnam**  
T +84-974270888  
sales.vt@hikvision.com

**Hikvision UAE**  
T +971-4-4432090  
salesme@hikvision.com

**Hikvision Singapore**  
T +65-6684-4718  
sg@hikvision.com

**Hikvision Spain**  
T +34-91-737-16-55  
info.es@hikvision.com

**Hikvision Tashkent**  
T +99-87-1238-9438  
uzb@hikvision.ru

**Hikvision Hong Kong**  
T +852-2151-1761  
info.hk@hikvision.com

**Hikvision Russia**  
T +7-495-669-67-99  
sateru@hikvision.com

**Hikvision Korea**  
T +82-(0)31-731-8817  
sales.korea@hikvision.com

**Hikvision Poland**  
T +48-22-460-01-50  
info.pl@hikvision.com

**Hikvision Indonesia**  
T +62-21-2933759  
Sales.Indonesia@hikvision.com

**Hikvision Colombia**  
sales.colombia@hikvision.com