

## DS-KIS7021Y-S Video Intercom Two-Wire Bundle



- 2-wire digital IP video intercom kit for villa or house, 1 call button, stainless steel

### Intercom Bundle stainless steel

KIS7021Y-S

1x DS-KD8003Y-IME2/NS, 1x DS-KD-KK/S, 1x DS-KH6320Y-WTE2/White (including 16GB TF card) , 1x DS-KAD706Y, 1x DS-KAW60-2N, front cover with 1 call button and gangbox for flush mount installation

## ▪ Specification

<b>Door station</b>	
<b>System parameters</b>	
Processor	Embedded microcontroller
Operation system	Embedded Linux operation system
<b>Display parameters</b>	
Camera	2MP super definition camera
Resolution	Main stream: 1920 × 1080, (720p configurable); sub stream: 720 × 480
Night vision	Support low light and IR light supplement mode
Backlight compensation	Support
Digital noise reduction	Support
WDR	True WDR
Field of view	Horizontal 146°, vertical 82°
Video Compression Standard	H.264
Stream	Main stream: 1080p@30fps, 720p@30fps (configurable); sub stream: D1
Motion detection	Support
Flash-avoid frequency	50 Hz, 60 Hz
<b>Audio parameters</b>	
Audio input	Built-in omnidirectional microphone
Audio output	Loudspeaker, 20 cm sound effect > 80 db
Audio quality	Noise suppression and echo cancellation
Audio compression standard	G.711 U
Audio compression Rate	64 Kbps
Audio intercom	Full-duplex two-way audio intercom
<b>Device interface</b>	
Debugging port	1
RS-485	1 (1 for Hikvision's sub module communication)
Alarm input	4 (2 exit buttons and 2 door contacts by default)
Lock control	2 (2 relay, max to 30 VDC, 2 A)
TAMPER switch	1
Power interface	Two-wire
<b>General</b>	
Working temperature	-40 °C to 60 °C (-40 °F to 140 °F)
Working humidity	10% to 90%
Dimension	100 mm × 98 mm × 42 mm (3.94" × 7.8" × 1.65")
Installation	Wall mounting
Protection level	IP 65
Power input	Powered by KAD704Y or KAD706Y series distributor
<b>Video Intercom Nametag Module</b>	
<b>System parameters</b>	
Processors	Embedded MCU Processor
<b>Interfaces</b>	
RS-485	2 (1 input, 1 output)

Power interface	1
<b>General</b>	
Power consumption	≤ 2 W
Button	1
Installation	Flush mounting, surface mounting
Protective level	IP65
Working temperature	-40° C to +55° C (-40° F to 131° F)
Working humidity	10% to 95%
Dimension	98,5 mm × 100 mm × 34,2 mm
Power supply	12 VDC (powered for other module)
<b>Indoor station</b>	
<b>System parameters</b>	
Operation system	Embedded Linux operation system
Memory	128 MB
Flash	32 MB
<b>Display parameters</b>	
Display screen	7-inch TFT LCD
Display resolution	1024 × 600
Operation method	Capacitive touch
<b>Audio parameters</b>	
Audio input	Built-in omnidirectional microphone
Audio output	Built-in loudspeaker
Audio quality	Noise suppression and echo cancellation
Volume	Local or software control
Audio compression standard	G.711 U, G.711 A
Audio compression Rate	64 Kbps
<b>Network parameters</b>	
Wired network	Two-wire network
Wireless network	Wi-Fi 802.11b/g/n
Protocol	TCP/IP, SIP, RTSP
<b>Device interface</b>	
Network interface	Two-wire interface
RS-485	1
Alarm input	8 zones alarm input
Relay output	2 (30 V Max.)
TF card	Support, Max. 128 GB
<b>General</b>	
Power supply	Powered by KAD704Y or KAD706Y distributor
Power consumption	≤ 4 W
Working temperature	-10 °C to 50 °C (14 °F to 122 °F)
Working humidity	10% to 90%
Dimensions (W × H × D)	200 mm × 140 mm × 23.6 mm (7.87" × 5.51" × 0.93")

Video Audio Distributor		
<b>Interface</b>		
Network interface	1 RJ45	
Two-wire interface	6 (2 for cascading and 4 for devices)	
Signal indicator	6	
Power indicator	1	
Reset	1	
<b>General</b>		
Power supply	24 VDC	
Power consumption	CH1 to CH5 < 4 W, CH6 < 8 W	
Working temperature	-10 °C to 55 °C (14 °F to 131 °F)	
Working humidity	10% to 90%	
<b>Front Cover and Gang Box</b>		
<b>Parameters</b>	<b>Cover</b>	<b>Gang box</b>
Material	Stainless steel / Stainless steel RAL7016	Plastic
Working temperature	-40° C to +55° C (-40° F to 131° F)	
Working humidity	10% to 95%	
Dimension	134 x 236 x 4 mm	237 x 134 x 56 mm

## Dimension

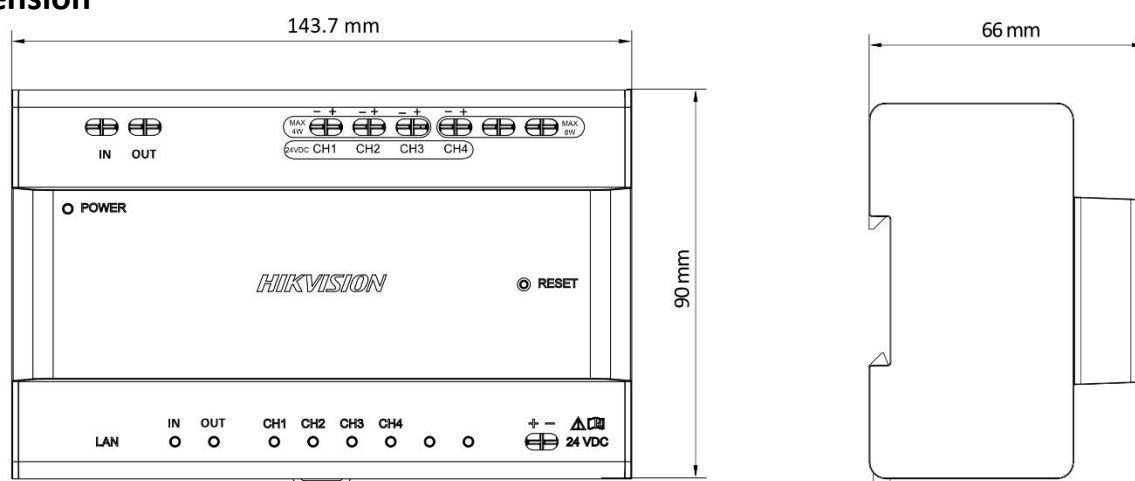

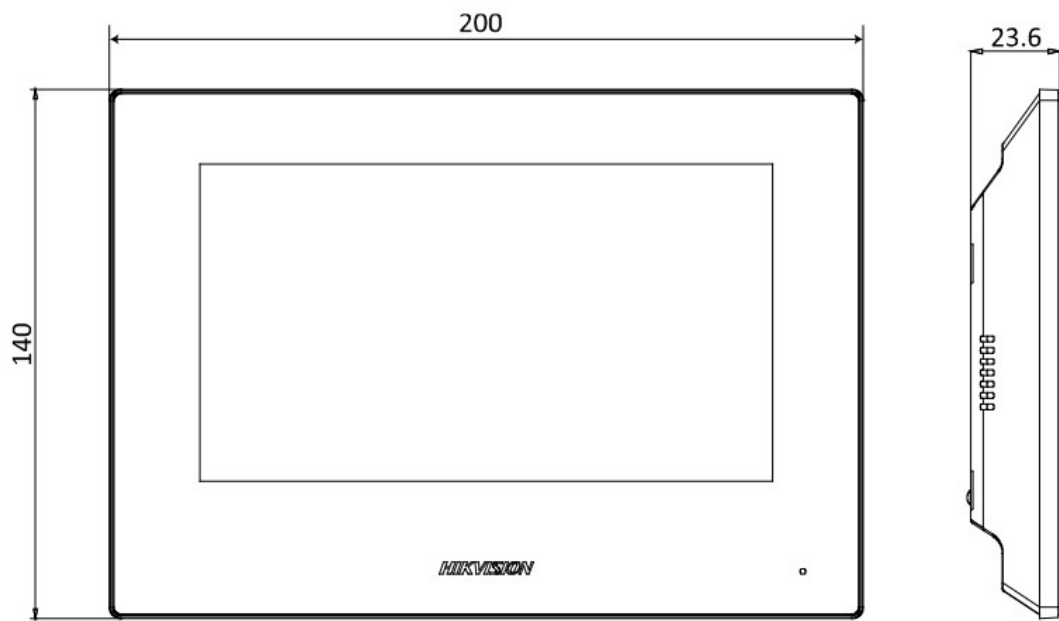
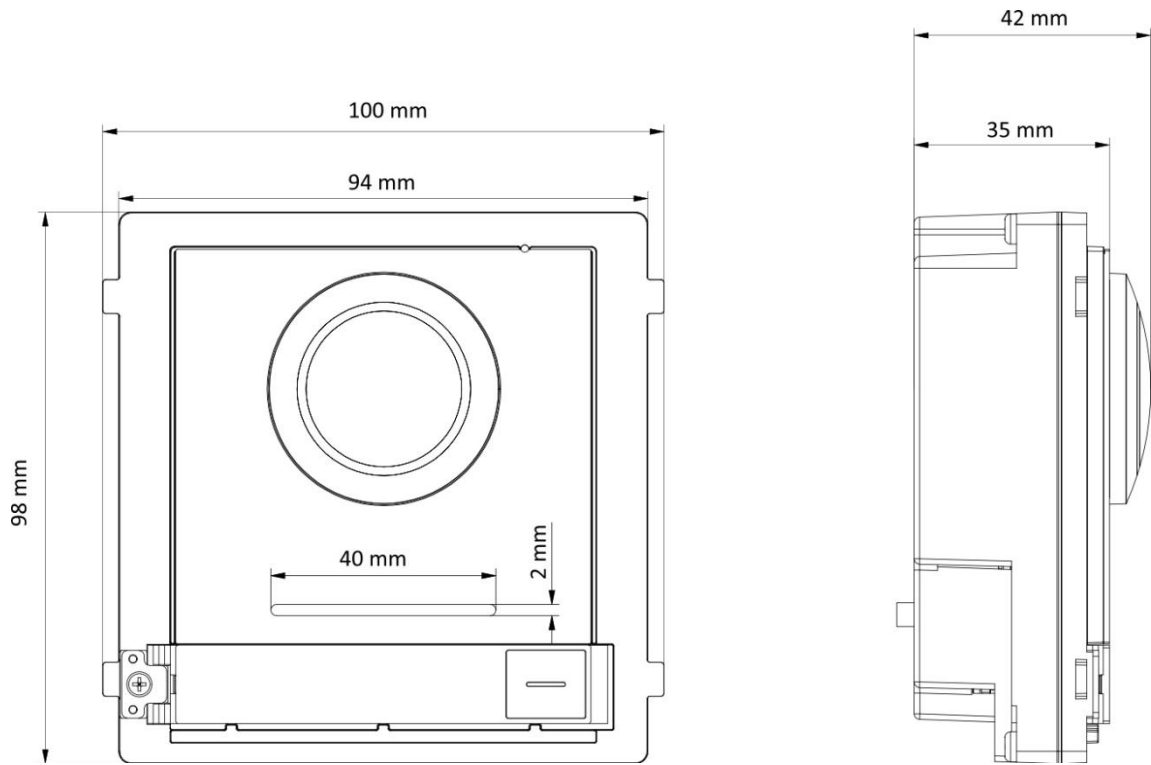

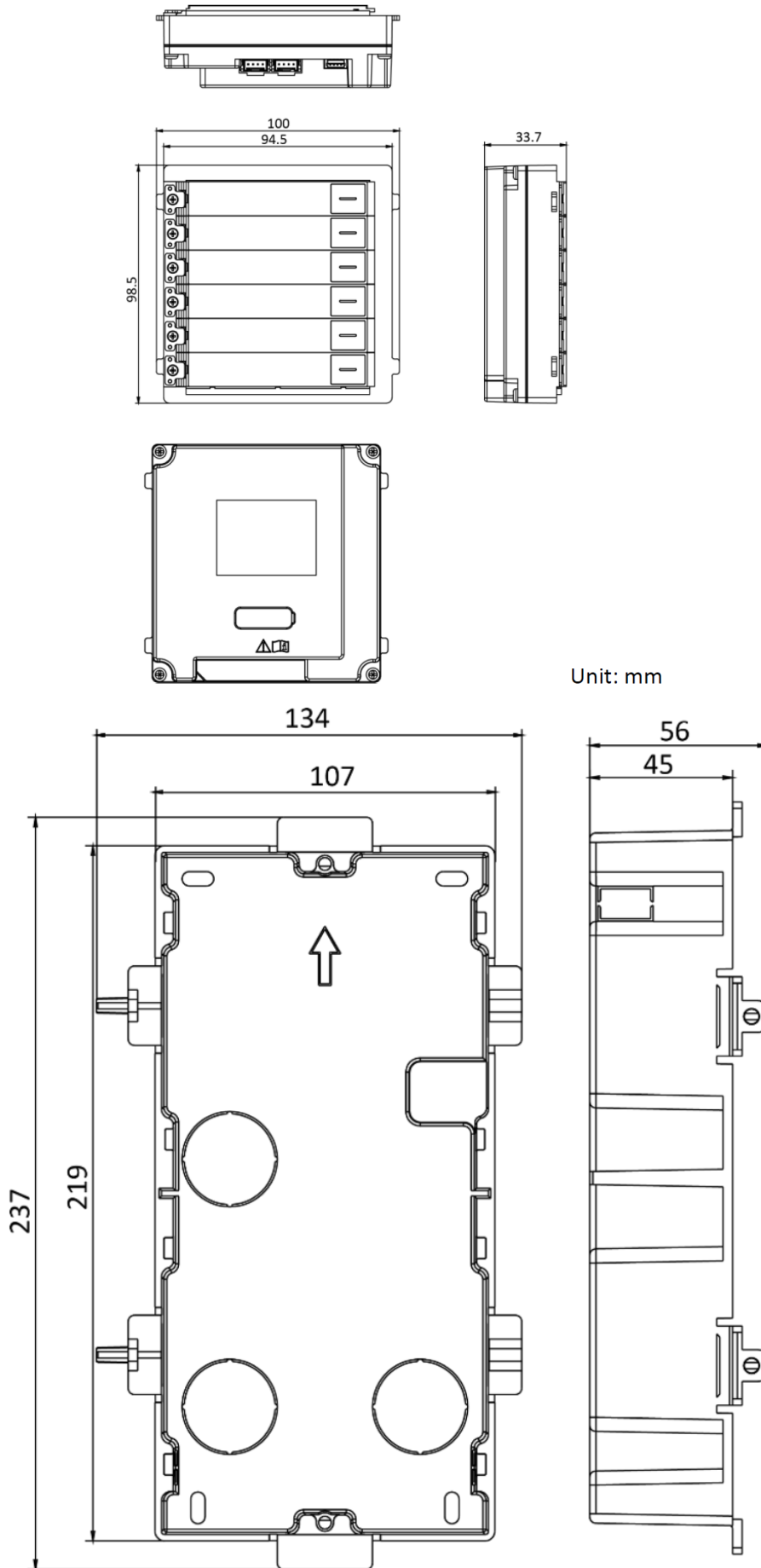

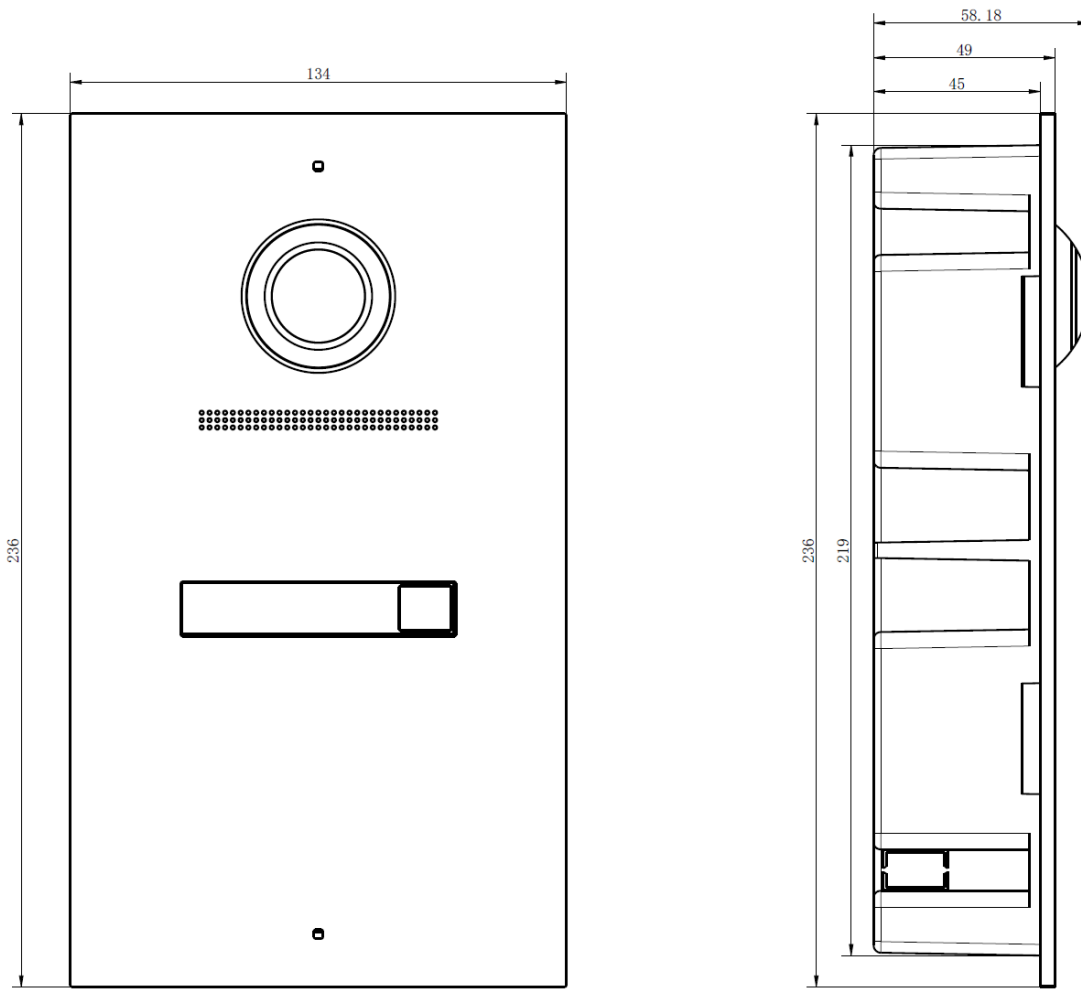

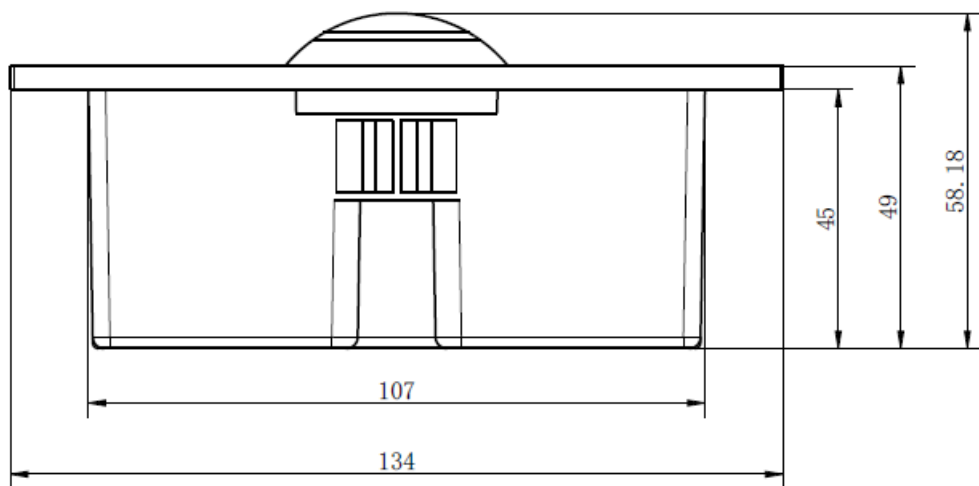

Unit mm



▪ **Accessory**

▪ **Optional**

DS-KAD706Y	DS-KD8003Y-IME2	DS-KH6320Y-WTE2
 A silver, rectangular device with a small screen and several buttons, likely a video intercom or access control unit.	 A black, square-shaped device with a circular lens in the center, likely a camera or sensor.	 A black, rectangular device with a large screen displaying a Windows-style interface, likely a touch-screen monitor or control panel.



**Headquarters**

No.555 Qianmo Road, Binjiang District,  
Hangzhou 310051, China  
T +86-571-8807-5998  
www.hikvision.com



Follow us on social media to get the latest product and solution information.

