

DS-2TD4228T-10/S2

Thermal & Optical Bi-spectrum Network Speed Dome



Hikvision DS-2TD4228T-10/S2 Thermal & Optical Bi-spectrum Network Speed Dome is applied to manufacture process supervision of pyrophoric materials in factories, electric substation, and hydropower station. The accurate temperature measurement system sends you alarms to protect you from property loss.

- Perimeter Protection function: line crossing, intrusion, region entrance and exit
- Temperature exception alarm for fire prevention, $-20\text{ }^{\circ}\text{C}$ to $550\text{ }^{\circ}\text{C}$ ($-4\text{ }^{\circ}\text{F}$ to $1022\text{ }^{\circ}\text{F}$), Max. ($\pm 2\text{ }^{\circ}\text{C}$, $\pm 2\%$)
- Fire detection algorithm
- 256×192 (the resolution of output image is 1280×720) resolution $12\text{ }\mu\text{m}$, VOx UFPA, NETD $\leq 35\text{ mK}$ ($25\text{ }^{\circ}\text{C}$, $F\# = 1.0$)
- Image processing technology: Liner, histogram, and self-adaptive thermal AGC mode, DDE, 3D DNR
- High quality detector with 10 years warranty
- Smart tracking: Panorama tracking, Event tracking and Multi-scene patrol tracking
- Smart tracking linkage: thermal view and optical view
- Smoke detection for fire prevention

▪ Specification

Thermal Module	
Image Sensor	Vanadium Oxide Uncooled Focal Plane Arrays
Resolution	256 × 192 (the resolution of output image is 1280 × 720)
Pixel Interval	12 μm
Response Waveband	8 μm to 14 μm
NETD	Less than 35 mK (@25 °C, F#=1.0)
Focal Length	10 mm
Focus Mode	Athermalized
IFOV	1.2 mrad
Aperture	F1.0
Field of View	18.1°×13.6° (H × V)
Min. Focusing Distance	1.5m
Digital Zoom	×2, ×4, ×8
Optical Module	
Image Sensor	1/2.8" Progressive Scan CMOS
Resolution	2688 × 1520, 4 MP
Min. Illumination	Color: 0.05 Lux @(F1.2, AGC ON), B/W: 0.01 Lux @(F1.2, AGC ON)
Field of View	58.8° × 34.4° (H × V) to 2.18° × 1.2° (H × V)
Focal Length	4.8-153 mm, 32x
Aperture (Range)	F1.2-F4.4
Focus Mode	Auto/Semi-auto/Manual
Shutter Speed	1s to 1/100,000s
WDR	120 dB
Optical Defog	No, support algorithmic defog
Image Effect	
Picture in Picture	Display partial image of thermal channel on the full screen of optical channel
Target Coloration	Supported in white hot and black hot mode.
PTZ	
Movement Range	Pan: 360° Continuous Rotate; Tilt: From -5° to + 90° (auto flip)

Pan Speed	Configurable, From 0.1°/s to 200°/s, Preset Speed: 240°/s
Tilt Speed	Configurable, From 0.1°/s to 105°/s, Preset Speed: 200°/s
Proportional Zoom	Yes
Presets	300 in total, 273 are configurable.
Patrol Scan	8; Up to 32 Presets Per Patrol
Pattern Scan	4; More Than 10 Minutes Per Pattern
Power Off Memory	Yes
Park	Preset/Pattern Scan/Patrol Scan/Auto Scan/Tilt Scan/Random Scan/Frame Scan/Panorama Scan
PT Status	Turn On/Turn Off
Scheduled Task	Preset/Pattern Scan/Patrol Scan/Auto Scan/Tilt Scan/Random Scan/Frame Scan/Panorama Scan/Doom Reboot/Doom Adjust/Aux Output
Illuminator	
IR Distance	Up to 100m
IR Intensity and Angle	Automatically adjusted
Smart Function	
VCA	Support 4 VCA rule types (Line Crossing, Intrusion, Region Entrance, and Region Exiting), up to 10 scenes and 8 VCA rules for each scene
Temperature Measurement	Support 3 temperature measurement rule types, 273 presets as scene, 21 rules of each scene (10 points, 10 areas, and 1 line)
Temperature Range	-20 °C to 550 °C (-4 °F to 1022 °F)
Temperature Accuracy	± 8 °C (±14.4 °F)
Fire Detection	Dynamic fire detection, up to 10 fire points detectable.
Video and Audio	
Main Stream	Optical channel 50 Hz:25 fps (2688 × 1520, 1920×1080, 1280×960, 1280×720) 60 Hz:30 fps (2688 × 1520, 1920×1080, 1280×960, 1280×720) Thermal channel 25 fps (1280×720, 704 × 576, 640 ×512, 256× 192)

Sub-stream	Optical channel 50 Hz:25 fps (704 × 576, 352 × 288) 60 Hz:30 fps (704 × 576, 352 × 288) Thermal channel 25 fps (704 × 576, 640 × 512, 256 × 192)
Video Compression	Main stream: H.265+/H.265/H.264+/ H.264 Sub-stream: H.265/H.264/MJPEG
Audio Compression	G.711u/G.711a/G.722.1/MP2L2/G.726/PCM
Network	
Protocols	IPv4/IPv6, HTTP, HTTPS, 802.1x, Qos, FTP, SMTP, UPnP, SNMP, DNS, DDNS, NTP, RTSP, RTCP, RTP, TCP, UDP, IGMP, ICMP, DHCP, PPPoE
Network Storage	MicroSD/SDHC/SDXC card (up to 256 G) local storage, and NAS (NFS, SMB/CIFS), auto network replenishment (ANR)
API	ISAPI, HIKVISION SDK, third-party management platform, ONVIF (Profile S, Profile G, Profile T)
Simultaneous Live View	Up to 20 channels
User/Host level	Up to 32 users, 3 levels: Administrator, Operator, User
Security	User authentication (ID and password), MAC address binding, HTTPS encryption, IEEE 802.1x access control, IP address filtering
Client	iVMS-4200, Hik-Connect
Web Browser	Live view (plug-in allowed) : Internet Explorer 11 Live view (plug-in free) : Chrome 57.0 +, Firefox 52.0 + Local service : Chrome 57.0+, Firefox 52.0 +
Interface	
Alarm Input	7-ch inputs (0-3.3 VDC)
Alarm Output	2-ch relay outputs, alarm response actions configurable
Alarm Action	Preset/Patrol Scan/Pattern Scan/SD Card Record/Relay Output/Smart capture/FTP upload/Email linkage
Audio Input	LINE_IN Input/MIC Input; Peak: From 2 to 2.4V[p-p]; Output Impedance: 1KΩ±10%
Audio Output	Linear Level; Impedance: 600 Ω
Communication Interface	1, RJ45 10 M/100 M Self-adaptive Ethernet interface. 1, RS-485 interface

Analog Video Output	1.0 V [p-p]/75 Ω, BNC for thermal channel
General	
Web Client Language	32 languages English, Russian, Estonian, Bulgarian, Hungarian, Greek, German, Italian, Czech, Slovak, French, Polish, Dutch, Portuguese, Spanish, Romanian, Danish, Swedish, Norwegian, Finnish, Croatian, Slovenian, Serbian, Turkish, Korean, Traditional Chinese, Thai, Vietnamese, Japanese, Latvian, Lithuanian, Portuguese (Brazil)
Power Supply	24VAC ± 20%, two-core terminal block 36VDC ± 20%, two-core terminal block 48VDC ± 20%, two-core terminal block Hi-PoE
Power Consumption	Max 30 W
Working Temperature/Humidity	-30°C to 60°C (-22°F to 140°F), 90% or less
Protection Level	IP66 Standard; TVS 6000V Lightning Protection, Surge Protection and Voltage Transient Protection
Dimension	305 mm × 185 mm × 163 mm (12.01 " × 7.28 " × 6.42 ")
Weight	Approx. 3.9Kg (8.6lb)

▪ Range Table

VCA Range (Vehicles: 1.4 × 4.0 m)	VCA Range (Humans: 1.8 × 0.5 m)	Temperature Measurement (Object: 0.5 × 0.5 m)	Temperature Measurement (Object: 0.2 × 0.2 m)	Fire Detection (Object: 2 × 2 m)	Fire Detection (Object: 1 × 1 m)
240 m	80 m	83 m	33 m	833 m	417 m

▪ DORI

* The table is only for reference and the performance may vary according to different environment.

* The optimal human detection, recognition, and identification distances are calculated according to Johnson' s Criteria.

Detection Range: In order to distinguish an object from the background, the object must be covered by 1.5 or more pixels.

Recognition Range: In order to classify the object (animal, human, vehicle, etc.), the object must be covered by 6 or more pixels.

Identification Range: In order to identify the object and describe it in details, the object must be covered by 12 or more pixels.

Detection Range (Vehicles: 1.4 × 4.0 m)	Detection Range (Humans: 1.8 × 0.5 m)	Recognition Range (Vehicles: 1.4 × 4.0 m)	Recognition Range (Humans: 1.8 × 0.5 m)	Identification Range (Vehicles: 1.4 × 4.0 m)	Identification Range (Humans: 1.8 × 0.5 m)
1278 m	417 m	319 m	104 m	160 m	52 m

▪ Available Model





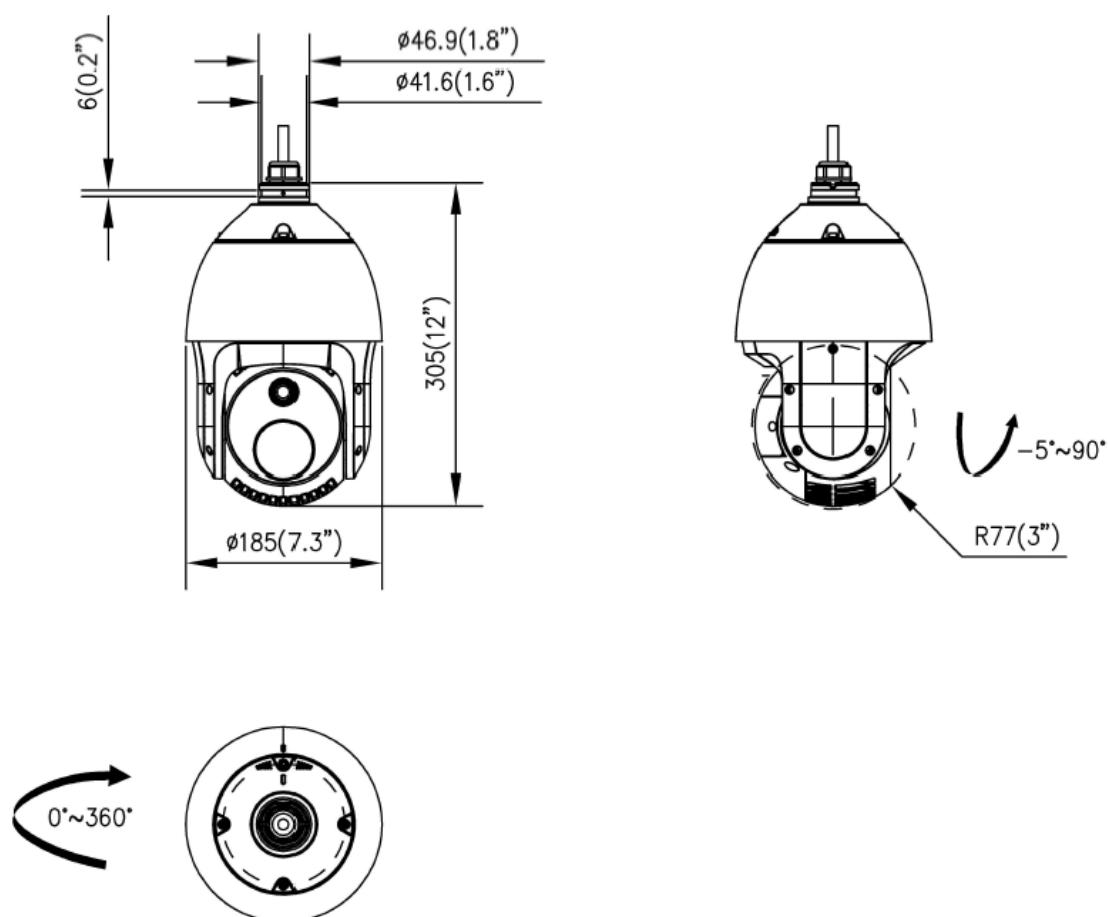







DS-2TD4228T-10/S2

▪ Dimension



▪ **Accessory**

▪ **Optional**

<p>DS-1663ZJ Ceiling Mount</p> 	<p>DS-1604ZJ-corner Corner Mount</p> 	<p>DS-1604ZJ-box Wall Mount</p> 	<p>DS-1604ZJ-pole Vertical Pole Mount</p> 	<p>DS-1661ZJ Pendant Mount</p> 
<p>DS-1673ZJ Vertical Pole Mount</p> 	<p>DS-1667ZJ Pendant Mount</p> 	<p>DS-1602ZJ Wall mount</p> 	<p>DS-1604ZJ-BOX-POLE Pole Mount</p> 	<p>DS-1662ZJ Pendant Mount</p> 
<p>DS-1619ZJ Pendant Mount</p> 	<p>DS-1604ZJ-BOX-CORNER Wall Mount with Junction Box</p> 		<p>DS-1660ZJ Parapet Wall Mount</p> 	

COMPLIANCE NOTICE: The thermal series products might be subject to export controls in various countries or regions, including without limitation, the United States, European Union, United Kingdom and/or other member countries of the Wassenaar Arrangement. Please consult your professional legal or compliance expert or local government authorities for any necessary export license requirements if you intend to transfer, export, re-export the thermal series products between different countries.

Headquarters

No.555 Qianmo Road, Binjiang District,
Hangzhou 310051, China
T +86-571-8807-5998
www.hikvision.com



Follow us on social media to get the latest product and solution information.

